

## KLT-M9K-MT9M114 V5.1

### 1.3MP OnSemi MT9M114 Parallele DVP-Schnittstelle Fester Fokus Kameramodul



Vorderansicht



Rückansicht

#### Spezifikationen

|                                 |                                     |
|---------------------------------|-------------------------------------|
| <b>Kameramodul Nr.</b>          | <b>KLT-M9K-MT9M114 V5.1</b>         |
| <b>Auflösung</b>                | 1.3MP                               |
| <b>Bildsensor</b>               | MT9M114                             |
| <b>Sensorart</b>                | 1/6"                                |
| <b>Pixel Größe</b>              | 1.9 um x 1.9 um                     |
| <b>EFL</b>                      | 2.00 mm                             |
| <b>F.NO</b>                     | 2.40                                |
| <b>Pixel</b>                    | 1296 x 976                          |
| <b>Betrachtungswinkel</b>       | 75.0°(DFOV) 60.0°(HFOV) 47.0°(VFOV) |
| <b>Linsenabmessungen</b>        | 6.00 x 6.00 x 3.54 mm               |
| <b>Modulgröße</b>               | 38.50 x 12.50 mm                    |
| <b>Modultyp</b>                 | Fester Fokus                        |
| <b>Schnittstelle</b>            | DVP-Parallel                        |
| <b>Autofokus-VCM-Treiber-IC</b> | Keiner                              |
| <b>Linsenmodell</b>             | KLT-LENS-TR311B-H211-BD             |
| <b>Linsentyp</b>                | 650 nm IR-Schnitt                   |
| <b>Betriebstemperatur</b>       | -30°C to +70°C                      |
| <b>Gegenstecker</b>             | FH12-24S-0.5SH                      |

**KLT-M9K-MT9M114 V5.1****1.3MP OnSemi MT9M114 Parallele DVP-Schnittstelle  
Fester Fokus Kameramodul**

Ansicht von oben



Seitenansicht



Untersicht

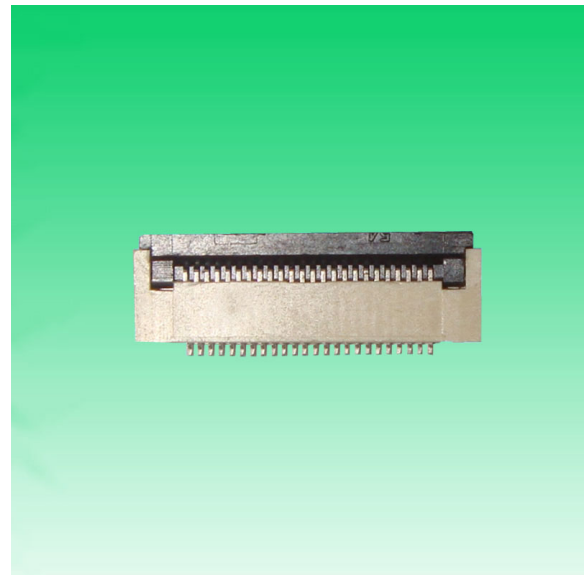

Gegenstecker



# CMOS CAMERA MODULES



*your BEST camera module partner*

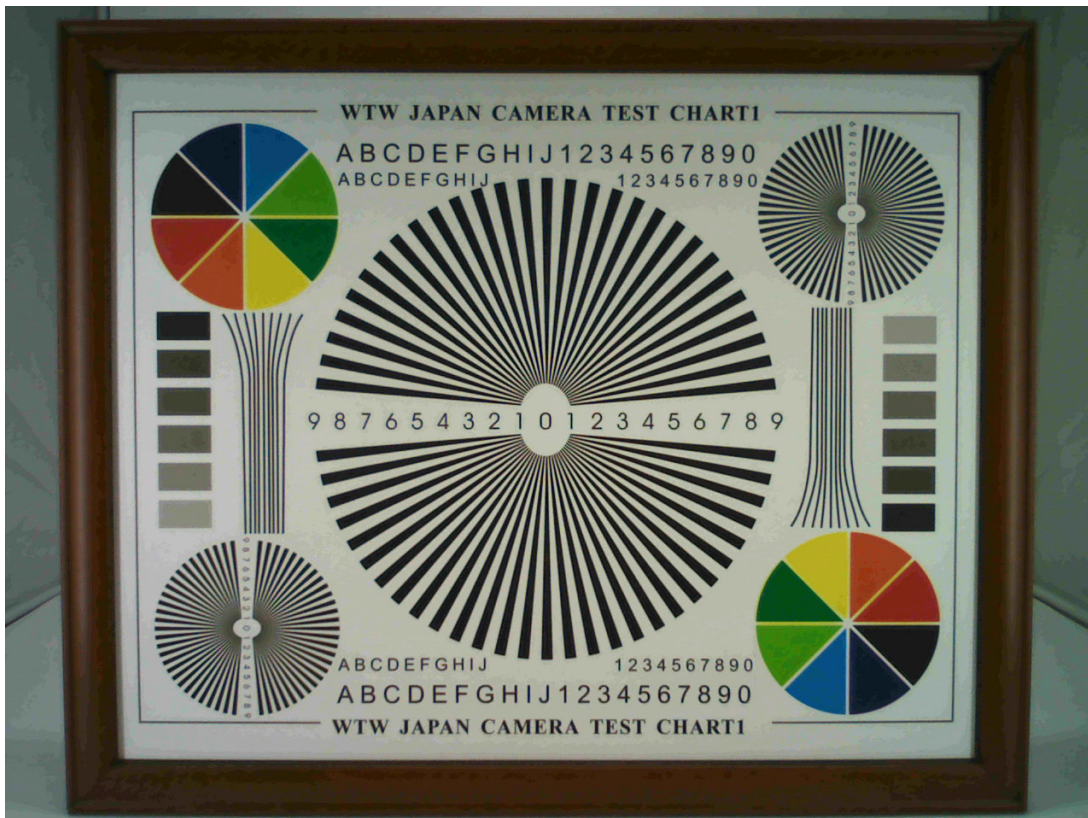

[www.KaiLapTech.com](http://www.KaiLapTech.com) [sales@KaiLapTech.com](mailto:sales@KaiLapTech.com) Tel: (852) 6908 1256 Fax: (852) 3017 6778

All rights reserved @ Kai Lap Technologies Group Ltd. Specifications subject to change without notice.



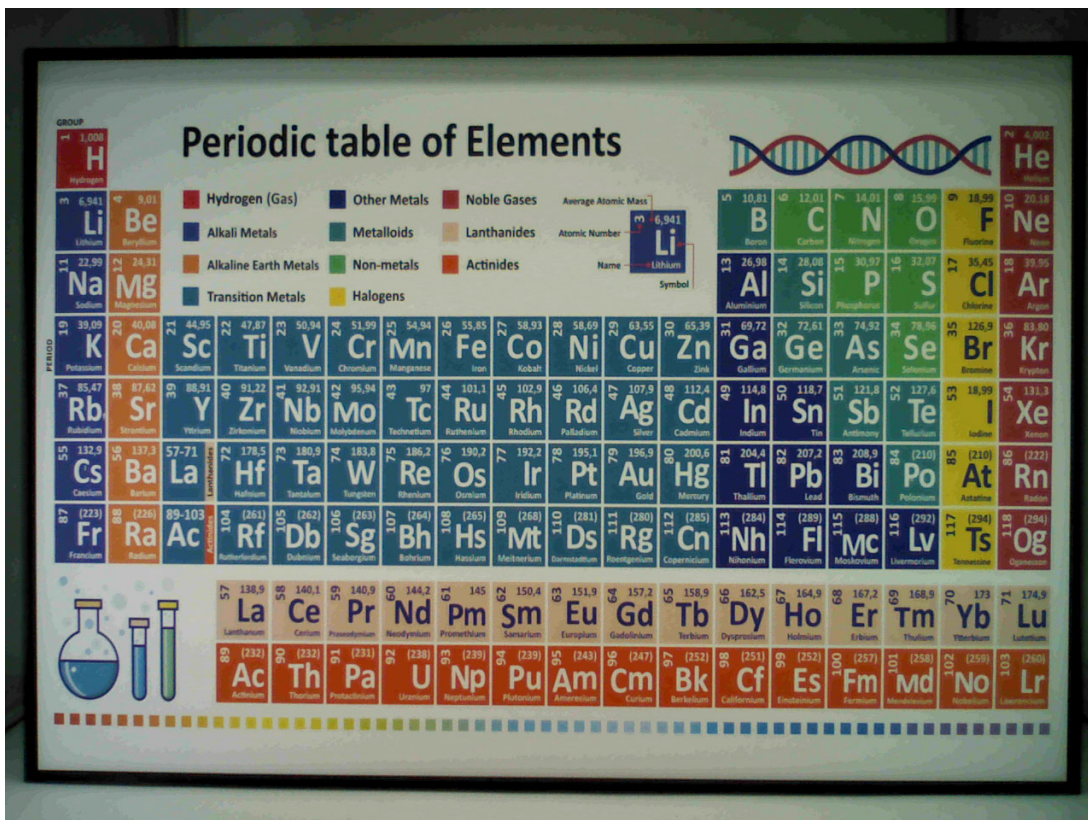

[www.KaiLapTech.com](http://www.KaiLapTech.com) [sales@KaiLapTech.com](mailto:sales@KaiLapTech.com) Tel: (852) 6908 1256 Fax: (852) 3017 6778

# ROHS

## PIN SIGNAL

|    |             |
|----|-------------|
| 1  | FLASH       |
| 2  | AGND        |
| 3  | SDATA       |
| 4  | VAA 2.8V    |
| 5  | SCLK        |
| 6  | RESET       |
| 7  | FRAME_VALID |
| 8  | CONFIG      |
| 9  | LINE_VALID  |
| 10 | NC          |
| 11 | VDD_IO 1.8V |
| 12 | DOUT[7]     |
| 13 | EXTCLK      |
| 14 | DOUT[6]     |
| 15 | DGND        |
| 16 | DOUT[5]     |
| 17 | PIXCLK      |
| 18 | DOUT[4]     |
| 19 | DOUT[0]     |
| 20 | DOUT[3]     |
| 21 | DOUT[1]     |
| 22 | DOUT[2]     |
| 23 | DGND        |
| 24 | DGND        |

NOTE:  
1.The device slave address:0x90

### Parameters:

#### 1、Sensor specification:

Image Sensor: MT9M114  
Pixel: 1.9umx1.9um  
Lens Type: 1/6  
Important Voltage Description: DVDD1.8V

#### 2、Lens specification:

FOV: 75°(D);60°(H);4.7°(V);  
F/NO.: 2.4  
TV distortion: <1.5%  
Focal length: 2.0mm  
Composition: 3P+IR FILTER  
IR Cut Coating: 650nm±10nm@50%

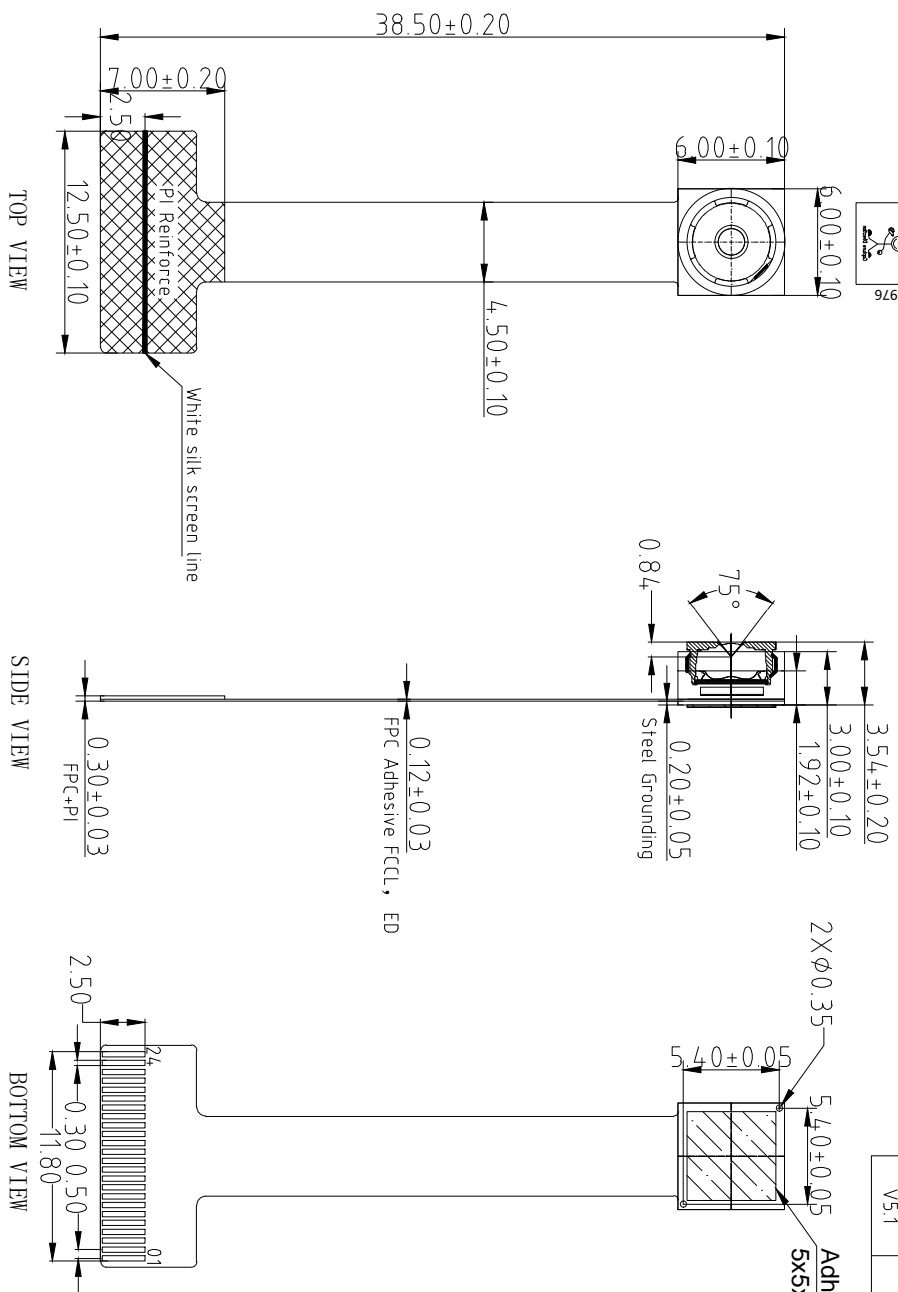
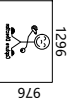

| Version | Information                      | Date       |
|---------|----------------------------------|------------|
| V1.0    | First Version                    | 11-22-2017 |
| V2.0    | Update the PIN 1 and lens holder | 11-27-2017 |
| V2.1    | Add adhesive tape                | 11-11-2019 |
| V4.1    | Extend FPC length                | 10-8-2020  |
| V5.1    | Add PIN 6 reset                  | 3-4-2021   |

# Kai Lap Technologies Group Ltd

|             |           |                  |                      |
|-------------|-----------|------------------|----------------------|
| Designed By | Kevin     | Model Name:      | KLT-M9K-MT9M114_V5.1 |
| Checked By  | Aouly Yan | Projection Type: | Third Angle          |
|             |           | Unit:            | mm                   |
|             |           | Scale:           | 1:1                  |
|             |           | Material:        | -----                |
|             |           | Sheet:           | 1 of 1               |
|             |           | Version:         | 1/0                  |



Lens Model: KLT-LENS-TR311B-H211-BD

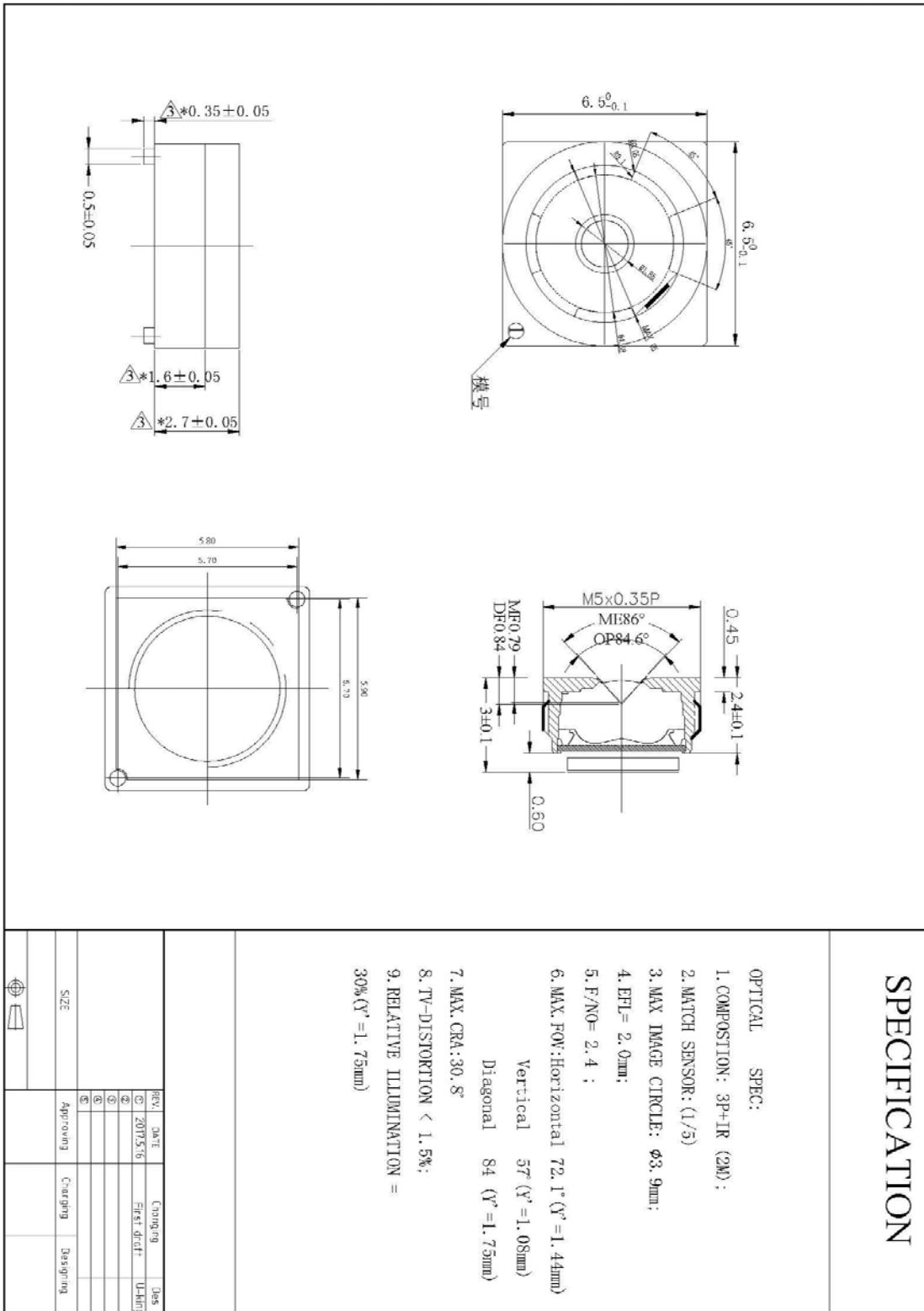

# 0.5mm and 1mm Pitch Connectors For FPC/FFC

## FH12 Series



### ■ Features

#### 1. Ease of Use and Space Savings

Only one finger or 6.9N (Newtons) of force is required to lock Hirose's rotational actuator (flip-lock) as compared to using 2 fingers and 39.2N to close a FFC/FPC connector from our competition.

The Flip-Lock design also allows customers to place 2 or more connectors side by side as there is no need to waste additional board space for a side latch.

#### 2. Strengthened Flip-lock Actuator

The standard Flip-Lock requires only 2.0mm height above the board. A strengthened lock lever is available which only requires an additional 0.4mm.

#### 3. Supports Thin FPC (0.18mm)

Hirose does not require double-sided FPC to have any additional strengthening plate or stiffener and can therefore support a thickness of as little as 0.18mm +/- 0.05.

#### 4. Hirose Ensures Reliability

Hirose's patented half tuning fork contacts maintain the required normal force without relying on the connector housing. With our competitor's conventional products the housing walls support the contact force, which does not provide for long-term reliability.

#### 5. Prevention of Solder Bridge

Excess solder cavity absorbs excessive solder and avoids solder bridging.

#### 6. Three different assembly types

FH12 is offered in Top & Bottom Contact and Vertical Mount and offered in both a 0.5mm contact pitch as well as a 1.0mm contact pitch (bottom contact only).

### ■ Applications

Notebook computers, printers, PDAs, digital cameras and other compact devices for interconnecting the main circuit board with the LCD, HDD or other device.

#### Rotating One-touch Mechanism

①



②



③



## Product Specifications

|        |                                 |  |  |
|--------|---------------------------------|--|--|
| Rating | Current rating: 0.5A DC(Note 1) | Operating Temperature Range: -40 to +70°C (Note 2)                   | Storage Temperature Range: -10 to +50°C (Note 3)                   |
|        | Voltage rating: 50V AC          | Operating Humidity Range: Relative humidity, 90% max.<br>(Not dewed) | Storage Humidity Range: Relative humidity, 90% max.<br>(Not dewed) |

|                |                        |                                  |
|----------------|------------------------|----------------------------------|
| Applicable FPC | t=0.3±0.05 Gold plated | t=0.18 ± 0.05 for FH12F-*S-0.5SH |
|----------------|------------------------|----------------------------------|

| Item                                 | Specification   | Conditions   |
|--------------------------------------|---|--|
| 1. Insulation resistance             | 500M ohms minimum   | 100V DC  |
| 2. Withstanding voltage              | No flashover or insulation breakdown.   | 150V AC/1 minute   |
| 3. Contact resistance                | 50m ohms maximum  | 1mA  |
| 4. Durability (Insertion/withdrawal) | Contact resistance: 50m ohms maximum<br>No damage, cracks, or parts dislocation.  | 20 cycles  |
| 5. Vibration                         | No electrical discontinuity of 1μs or more<br>Contact resistance: 50m ohms maximum.<br>No damage, cracks, or parts dislocation. | Frequency: 10 to 55 Hz, single amplitude of 0.75 mm,<br>2 hours in each of the 3 directions.                       |
| 6. Shock                             | No electrical discontinuity of 1μs or more<br>Contact resistance: 50m ohms maximum.<br>No damage, cracks, or parts dislocation. | Acceleration of 490 m/s <sup>2</sup> , 11 ms duration,<br>sine half-wave waveform, 3 cycles in each of the 3 axis. |
| 7. Humidity(Steady state)            | Contact resistance: 50m ohms maximum.<br>Insulation resistance: 50M ohms minimum.<br>No damage, cracks, or parts dislocation.   | 96 hours at 40°C and humidity of 90% to 95%  |
| 8. Temperature Cycle                 | Contact resistance: 50m ohms maximum.<br>Insulation resistance: 50M ohms minimum.<br>No damage, cracks, or parts dislocation.   | Temperature: -40°C → 15 to 35°C → 85°C → 15 to 35°C,<br>Time: 30 → 5 max. → 30 → 5 max.(minutes)<br>5 cycles       |
| 9. Resistance to Soldering heat      | No deformation of components affecting performance.   | Reflow: At the recommended temperature profile<br>Manual soldering: 350±5°C for 3 seconds                          |

Note 1: When passing the current through all of the contacts, use 70% of the current rating.

Note 2: Includes temperature rise caused by current flow.

Note 3: The term "storage" refers to products stored for long period of time prior to mounting and use. Operating Temperature Range and Humidity range covers nonconducting condition of installed connectors in storage, shipment or during transportation.

## Material

| Part           | Material                | Finish             | Remarks |
|----------------|-------------------------|--------------------|---------|
| Insulator      | Polyamide, LCP(60 pos.) | Color : Beige      | UL94V-0 |
| Actuator       | PPS                     | Color : Dark brown |         |
| Contact        | Phosphor bronze         | Gold plated        |         |
| Metal Fittings | Brass                   | Tin plated         |         |

## Ordering Information

**FH12**    **A** - **10** (**4**) - **S** **A** - **0.5** **SH** (**55**)  
 ①            ②            ③            ④            ⑤            ⑥            ⑦            ⑧            ⑨

|  |  |
|--|--|
| ① Series Name : FH12   | ⑤ Contact alignment: Single  |
| ② Blank : standard type<br>A : Top contact type<br>S : Type with strengthened flip-lock actuator<br>F : Type with 0.18mm FPC End Thickness | ⑥ Eccentric direction:<br>Blank : standard type<br>A : Eccentric type                  |
| ③ Standard type : Number of contacts<br>Eccentric type : Number of contacts in 0.5mm housing   | ⑦ Contacts Pitch : 0.5mm, 1mm  |
| ④ Standard type : Blank<br>Eccentric type : Number of contacts   | ⑧ Contact type<br>SH : SMT horizontal mounting type<br>SV : SMT vertical mounting type |
|  | ⑨ Plating specification<br>(55) : Gold plated  |

**FH12 Series 0.5mm and 1mm Pitch Connectors For FPC/FPC**

**Series Configuration**

| Pitch | Bottom Contact Type  | Top Contact Type   | Vertical mounting Type   |
|-------|--|--|--|
| 0.5mm |  <p><b>FH12- ** S-0.5SH</b> <b>P.12</b><br/>                     Number of contacts 6, 8, 10, 11, 12, 13, 14, 15, 16, 17, 18, 19, 20, 22, 24, 25, 26, 28, 30, 32, 33, 34, 35, 36, 40, 45, 50, 53</p>  |  |   |
|       | <p>Type with Strengthened Lock Lever</p>   |  |  |
|       | <p><b>FH12S- ** S-0.5SH</b> <b>P.13</b><br/>                     Number of contacts 30, 40, 45, 50, 53</p>   |  |  |
|       | <p>Type with 0.18mm FPC End Thickness</p>  |  |  |
|       | <p><b>FH12F- ** S-0.5SH</b> <b>P.14</b><br/>                     Number of contacts 6, 8, 10, 12, 13, 14, 15, 16, 18, 20, 22, 24, 25, 26, 28, 30, 32, 34, 36, 40</p>   |  |  |
| 1mm   |  <p>Standard <b>FH12- ** S-1SH</b> <b>P.18</b><br/>                     Eccentric <b>FH12- ** (***) SA-1SH</b><br/>                     Standard<br/>                     Number of contacts 5, 6, 7, 8, 9, 11, 12, 16, 17, 22, 26<br/>                     Eccentric<br/>                     Number of contacts 4, 6, 8, 10, 11, 14, 19, 24</p> |  |  <p><b>FH12- ** S-1SV</b> <b>P.19</b><br/>                     Number of contacts 6, 7, 8, 16, 20, 22, 24</p> |

## 0.5mm Pitch Bottom Contact Type

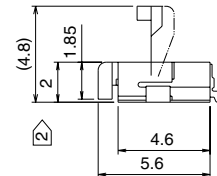
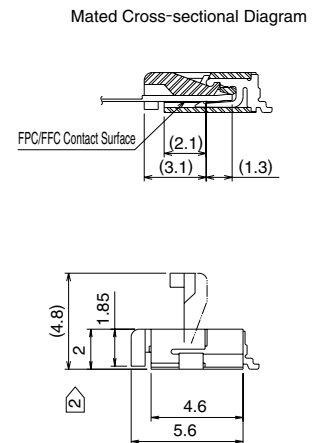

Unit:mm

| Part Number               | CL No.        | Number of Contacts | A    | B    | C    | D     | RoHS |
|---------------------------|---------------|--------------------|------|------|------|-------|------|
| FH12- 6S-0.5SH(55)        | 586-0582-5-55 | 6                  | 2.5  | 6.1  | 7.1  | 3.57  | YES  |
| FH12- 8S-0.5SH(55)        | 586-0744-5-55 | 8                  | 3.5  | 7.1  | 8.1  | 4.57  |      |
| FH12-10S-0.5SH(55)        | 586-0522-3-55 | 10                 | 4.5  | 8.1  | 9.1  | 5.57  |      |
| FH12-11S-0.5SH(55)        | 586-0600-5-55 | 11                 | 5    | 8.6  | 9.6  | 6.07  |      |
| FH12-12S-0.5SH(55)        | 586-0704-0-55 | 12                 | 5.5  | 9.1  | 10.1 | 6.57  |      |
| FH12-13S-0.5SH(55)        | 586-0549-0-55 | 13                 | 6    | 9.6  | 10.6 | 7.07  |      |
| FH12-14S-0.5SH(55)        | 586-0533-0-55 | 14                 | 6.5  | 10.1 | 11.1 | 7.57  |      |
| FH12-15S-0.5SH(55)        | 586-0523-6-55 | 15                 | 7    | 10.6 | 11.6 | 8.07  |      |
| FH12-16S-0.5SH(55)        | 586-0531-4-55 | 16                 | 7.5  | 11.1 | 12.1 | 8.57  |      |
| FH12-17S-0.5SH(55)        | 586-0606-1-55 | 17                 | 8    | 11.6 | 12.6 | 9.07  |      |
| FH12-18S-0.5SH(55)        | 586-0530-1-55 | 18                 | 8.5  | 12.1 | 13.1 | 9.57  |      |
| FH12-19S-0.5SH(55)        | 586-0534-2-55 | 19                 | 9    | 12.6 | 13.6 | 10.07 |      |
| FH12-20S-0.5SH(55)        | 586-0524-9-55 | 20                 | 9.5  | 13.1 | 14.1 | 10.57 |      |
| FH12-22S-0.5SH(55)        | 586-0532-7-55 | 22                 | 10.5 | 14.1 | 15.1 | 11.57 |      |
| FH12-24S-0.5SH(55)        | 586-0521-0-55 | 24                 | 11.5 | 15.1 | 16.1 | 12.57 |      |
| FH12-25S-0.5SH(55)        | 586-0692-3-55 | 25                 | 12   | 15.6 | 16.6 | 13.07 |      |
| FH12-26S-0.5SH(55)        | 586-0576-2-55 | 26                 | 12.5 | 16.1 | 17.1 | 13.57 |      |
| FH12-28S-0.5SH(55)        | 586-0612-4-55 | 28                 | 13.5 | 17.1 | 18.1 | 14.57 |      |
| Note ② FH12-30S-0.5SH(55) | 586-0525-1-55 | 30                 | 14.5 | 18.1 | 19.1 | 15.57 |      |
| FH12-32S-0.5SH(55)        | 586-0681-7-55 | 32                 | 15.5 | 19.1 | 20.1 | 16.57 |      |
| FH12-33S-0.5SH(55)        | 586-0520-8-55 | 33                 | 16   | 19.6 | 20.6 | 17.07 |      |
| FH12-34S-0.5SH(55)        | 586-0617-8-55 | 34                 | 16.5 | 20.1 | 21.1 | 17.57 |      |
| FH12-35S-0.5SH(55)        | 586-0740-4-55 | 35                 | 17.0 | 20.6 | 21.6 | 18.07 |      |
| FH12-36S-0.5SH(55)        | 586-0526-4-55 | 36                 | 17.5 | 21.1 | 22.1 | 18.57 |      |
| Note ② FH12-40S-0.5SH(55) | 586-0527-7-55 | 40                 | 19.5 | 23.1 | 24.1 | 20.57 |      |
| Note ② FH12-45S-0.5SH(55) | 586-0528-0-55 | 45                 | 22   | 25.6 | 26.6 | 23.07 |      |
| Note ② FH12-50S-0.5SH(55) | 586-0529-2-55 | 50                 | 24.5 | 28.1 | 29.1 | 25.57 |      |
| Note ② FH12-53S-0.5SH(55) | 586-0595-7-55 | 53                 | 26   | 29.6 | 30.6 | 27.07 |      |

Note 1 : Embossed tape reel packaging (2,000 pieces/reel).  
 Order by number of reels.

Note ② : If there is no problem with the connector height, we recommend the type with the strengthened Flip-lock actuator (FH12S-\*S-0.5SH).  
 Standard type connector height: 2 mm  
 Connector height of type with strengthened Flip-lock actuator: 2.4 mm

## Product Overview

### MT9M114: 1 MP 1/6" System-on-Chip

For complete documentation, see the data sheet.

ON Semiconductor's focus on pixel performance excellence enables the built-in advantages of having a high quality image sensor at the core of this SOC (System-on-Chip). ON Semiconductor's SOC's provide a variety of camera functions including auto focus, auto white balance, and auto exposure. SOC is a cost-effective, compact, one-chip solution providing exceptional image quality and ease of integration which can lower overall system costs and speed time to market.

### Applications

- Mobile

### Part Electrical Specifications

| Product            | Compliance             | Status | Type | Megapixels | Frame Rate (fps) | Optical Format | Shutter Type       | Pixel Size (µm) | Output Interface | Color | Package Type |
|--------------------|------------------------|--------|------|------------|------------------|----------------|--------------------|-----------------|------------------|-------|--------------|
| MT9M114EBLSTCZ-CR  | Pb-free<br>Halide free | Active | CMOS | 1.3        | 30               | 1/6 inch       | Electronic Rolling | 1.9 x 1.9       | Parallel<br>MIPI | RGB   | ODCSP-55     |
| MT9M114EBLSTCZ-CR1 | Pb-free<br>Halide free | Active | CMOS | 1.3        | 30               | 1/6 inch       | Electronic Rolling | 1.9 x 1.9       | Parallel<br>MIPI | RGB   | ODCSP-55     |

For more information please contact your local sales support at [www.onsemi.com](http://www.onsemi.com).

Created on: 9/30/2017

# MT9M114

## 1/6-inch 720p High-Definition (HD) System-On-a-Chip (SOC) Digital Image Sensor

The MT9M114 from ON Semiconductor is a 1/6-inch 1.26 Mp CMOS digital image sensor with an active-pixel array of 1296 (H) × 976 (V). It includes sophisticated camera functions such as auto exposure control, auto white balance, black level control, flicker avoidance, and defect correction. It is designed for low light performance. The MT9M114 produces extraordinarily clear, sharp digital pictures, making it the perfect choice for a wide range of applications, including mobile phones, PC and notebook cameras, and gaming systems.

**Table 1. KEY PERFORMANCE PARAMETERS**

| Parameter   | Typical Value   |
|---|---|
| Optical Format  | 1/6-inch  |
| Active Pixels   | 1296 (H) × 976 (V) = 1.26 Mp  |
| Pixel Size  | 1.9 μm × 1.9 μm   |
| Color Filter Array  | RGB Bayer   |
| Shutter   | Electronic Rolling Shutter (ERS)  |
| Input Clock Range   | 6–54 MHz  |
| Output MIPI Data Rate Maximum                             | 768 Mb/s  |
| Max. Frame Rate   | 30 fps Full Res<br>36.7 fps 720p<br>75 fps VGA<br>120 fps QVGA (Note 2) |
| Responsivity  | 2.24 V/Lux–sec (550 nm)   |
| SNR <sub>MAX</sub>  | 37 dB   |
| Dynamic Range   | 70.8 dB   |
| Supply Voltage  |   |
| Digital   | 1.7–1.95 V  |
| Analog  | 2.5–3.1 V   |
| I/O   | 1.7–1.95 V or 2.5–3.1 V   |
| PLL   | 2.5–3.1 V   |
| PHY   | 1.7–1.95 V  |
| Power Consumption   | 135 mW (Note 1)   |
| Operating Temperature Range<br>(Ambient) – T <sub>A</sub> | –30°C to 70°C   |
| Chief Ray Angle   | 27.7°   |
| Active Imager Size  | 2.46 mm (H) × 1.85 mm (V),<br>3.08 mm Diagonal                          |
| Package Options   | Bare Die, CSP   |

1. Power consumption for typical voltages and 720p output.
2. Reduced FOV.

### Features

- Superior Low-light Performance
- Ultra-low Power
- 720p HD Video at 30 fps



**ON Semiconductor®**

[www.onsemi.com](http://www.onsemi.com)

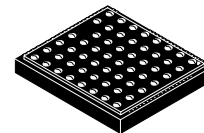

**ODCSP55 4.7x3.9  
CASE 570BP**

### ORDERING INFORMATION

See detailed ordering and shipping information on page 2 of this data sheet.

- Internal Master Clock Generated by On-chip Phase-locked Loop (PLL) Oscillator
- Electronic Rolling Shutter (ERS), Progressive Scan
- Integrated Image Flow Processor (IFP) for Single-die Camera Module
- Automatic Image Correction and Enhancement
- Arbitrary Image Scaling with Anti-aliasing
- Two-wire Serial Interface Providing Access to Registers and Microcontroller Memory
- Selectable Output Data Format: YCbCr, 565RGB, 555RGB, 444RGB, Processed Bayer, BT656, RAW8- and RAW8+2-bit
- Parallel and MIPI Data Output
- Independently Configurable Gamma Correction
- Adaptive Polynomial Lens Shading Correction
- UVC Interface
- Perspective Correction
- Multi-camera Synchronization

### Applications

- Embedded Notebook, Netbook, and Desktop Monitor Cameras
- Tethered PC Cameras
- Game Consoles
- Cell Phones, Mobile Devices, and Consumer Video Communications
- Surveillance, Medical, and Industrial Applications



Kameraanwendungen

*your BEST camera module partner*



Autopilot



Live-Streaming



Videokonferenz



Biometrische Eye-Tracker-Erkennung



Maschinelles Sehen



Agrarmonitor



Nachtsichtsicherheit



Drohnen- und Sport-Adlerungen



Interaktive Haustierkamera

[www.KaiLapTech.com](http://www.KaiLapTech.com) [sales@KaiLapTech.com](mailto:sales@KaiLapTech.com) Tel: (852) 6908 1256 Fax: (852) 3017 6778

All rights reserved @ Kai Lap Technologies Group Ltd. Specifications subject to change without notice.



*your BEST camera module partner*

## Kameraanwendungen



## IMAGING DEVICES





Referenztable für die Pinbelegungsdefinition des Kameramoduls

| OmniVision Sony Himax Samsung On-Semi Aptina Himax GalaxyCore PixArt Bildsensoren |   |
|---|---|
| Pin Signal  | Beschreibung  |
| DGND GND  | Masse für digitale Schaltung                            |
| AGND  | Masse für analoge Schaltung                             |
| PCLK DCK  | DVP-PCLK-Ausgang  |
| XCLR PWDN XSHUTDOWN STANDBY   | Abschalten aktiv hoch mit internem Pulldown-Widerstand  |
| MCLK XVCLK XCLK INCK  | Systemeingangsuhr                                       |
| RESET RST   | Aktiv Low mit internem Pull-up-Widerstand zurücksetzen  |
| NC NULL   | keine Verbindung  |
| SDA SIO_D SIOD  | SCCB-Daten  |
| SCL SIO_C SOIC  | SCCB-Eingangstakt                                       |
| VSYNC XVS FSYNC   | DVP-VSYNC-Ausgang                                       |
| HREF XHS  | DVP-HREF-Ausgang  |
| DOVDD   | Strom für E/A-Schaltung                                 |
| AFVDD   | Strom für VCM-Schaltung                                 |
| AVDD  | Strom für analoge Schaltung                             |
| DVDD  | Strom für digitale Schaltung                            |
| STROBE FSTROBE  | Strobe-Ausgang  |
| FSIN  | Synchronisieren Sie das VSYNC-Signal vom anderen Sensor |
| SID   | SCCB letzte Bit-ID-Eingabe                              |
| ILPWM   | mechanische Shutter-Ausgangsanzeige                     |
| FREX  | Rahmenbelichtung / mechanischer Verschluss              |
| GPIO  | Allzweckeingänge  |
| SLASEL  | I2C-Slave-Adresse auswählen                             |
| AFEN  | CEN-Chip aktivieren aktiv hoch auf VCM-Treiber-IC       |
| <b>MIPI Schnittstelle</b>   |   |
| MDN0 DN0 MD0N DATA_N DMO1N  | MIPI 1st negative Ausgabe der Datenspur                 |
| MDP0 DP0 MD0P DATA_P DMO1P  | MIPI 1st positiver Ausgang der Datenspur                |
| MDN1 DN1 MD1N DATA2_N DMO2N   | MIPI 2nd negative Ausgabe der Datenspur                 |
| MDP1 DP1 MD1P DATA2_P DMO2P   | MIPI 2nd positiver Ausgang der Datenspur                |
| MDN2 DN2 MD2N DATA3_N DMO3N   | MIPI 3rd negative Ausgabe der Datenspur                 |
| MDP2 DP2 MD2P DATA3_P DMO3P   | MIPI 3rd positiver Ausgang der Datenspur                |
| MDN3 DN3 MD3N DATA4_N DMO4N   | MIPI 4th negative Ausgabe der Datenspur                 |
| MDP3 DP3 MD3P DATA4_P DMO4P   | MIPI 4th positiver Ausgang der Datenspur                |
| MCN CLKN CLK_N DCKN   | MIPI Uhr negativer Ausgang                              |
| MCP CLKP MCP CLK_P DCKN   | MIPI Takt positiver Ausgang                             |
| <b>DVP Parallel Schnittstelle</b>   |   |
| D0 DO0 Y0   | DVP Datenausgabeport 0                                  |
| D1 DO1 Y1   | DVP Datenausgabeport 1                                  |
| D2 DO2 Y2   | DVP Datenausgabeport 2                                  |
| D3 DO3 Y3   | DVP Datenausgabeport 3                                  |
| D4 DO4 Y4   | DVP Datenausgabeport 4                                  |
| D5 DO5 Y5   | DVP Datenausgabeport 5                                  |
| D6 DO6 Y6   | DVP Datenausgabeport 6                                  |
| D7 DO7 Y7   | DVP Datenausgabeport 7                                  |
| D8 DO8 Y8   | DVP Datenausgabeport 8                                  |
| D9 DO9 Y9   | DVP Datenausgabeport 9                                  |
| D10 DO10 Y10  | DVP Datenausgabeport 10                                 |
| D11 DO11 Y11  | DVP Datenausgabeport 11                                 |



## Kamera-Zuverlässigkeitstest

| Reliability Inspection Item        |   | Testmethode                                 | Akzeptanzkriterium        |                           |
|------------------------------------|---|---|---------------------------|---------------------------|
| Kategorie                          | Artikel   |   |                           |                           |
| Umwelt                             | Lager Temperatur  | Hoch 60°C 96 Std                            | Temperaturkammer          | Keine anormale Situation  |
|                                    |   | Niedrig -20°C 96 Std                        | Temperaturkammer          | Keine anormale Situation  |
|                                    | Betriebs Temperatur   | Hoch 60°C 24 Std                            | Temperaturkammer          | Keine anormale Situation  |
|                                    |   | Niedrig -20°C 24 Std                        | Temperaturkammer          | Keine anormale Situation  |
|                                    | Feuchtigkeit  | 60°C 80% 24 Std                             | Temperaturkammer          | Keine anormale Situation  |
| Thermischer Schock                 | Hoch 60°C 0.5 Std<br>Niedrig -20°C 0.5 Std<br>Radfahren rein 24 Std | Temperaturkammer                            | Keine anormale Situation  |                           |
| Physisch                           | Falltest (Im freien Fall)   | Ohne Verpackung 60cm                        | 10 Mal auf Holzboden      | Elektrisch funktionsfähig |
|                                    |   | Mit Paket 60cm                              | 10 Mal auf Holzboden      | Elektrisch funktionsfähig |
|                                    | Vibrations Test   | 50Hz X-Axis 2mm 30 Minuten                  | Vibrationstisch           | Elektrisch funktionsfähig |
|                                    |   | 50Hz Y-Axis 2mm 30 Minuten                  | Vibrationstisch           | Elektrisch funktionsfähig |
|                                    |   | 50Hz Z-Axis 2mm 30 Minuten                  | Vibrationstisch           | Elektrisch funktionsfähig |
| Zugfestigkeit des Kabels Krafttest | Gewicht laden 4 kg<br>60 Sekunden<br>Radfahren rein 24 Std          | Zugprüfmaschine                             | Elektrisch funktionsfähig |                           |
| Elektrisch                         | ESD-Test  | Kontaktaufnahme 2 KV                        | ESD-Prüfmaschine          | Elektrisch funktionsfähig |
|                                    |   | Luftentladung 4 KV                          | ESD-Prüfmaschine          | Elektrisch funktionsfähig |
|                                    | Alterungstest   | On/Off 30 Sekunden<br>Radfahren rein 24 Std | Stromschalter             | Elektrisch funktionsfähig |
|                                    | USB-Anschluss   | On/Off 250 Mal                              | Einstecken und ausstecken | Elektrisch funktionsfähig |





| Inspektionsgegenstand |              | Untersuchungsmethode     | Inspektionsstandard         |   |
|-----------------------|--------------|--------------------------|-----------------------------|---|
| Kategorie             | Artikel      |                          |                             |   |
| Aussehen              | FPC oder PCB | Farbe                    | Das bloße Auge              | Größere Unterschiede sind nicht zulässig.                           |
|                       |              | Zerrissen/gehackt werden | Das bloße Auge              | Das Freilegen von Kupferrissen ist nicht zulässig.                  |
|                       |              | Markierung               | Das bloße Auge              | Klar, erkennbar (innerhalb von 30 cm Entfernung)                    |
|                       | Halterin     | Kratzer                  | Das bloße Auge              | Die Freilegung von Rissen im Inneren ist nicht zulässig             |
|                       |              | Lücke                    | Das bloße Auge              | Erfüllen Sie den Höhenstandard                                      |
|                       |              | Schraube                 | Das bloße Auge              | Stellen Sie sicher, dass Schrauben vorhanden sind (falls vorhanden) |
|                       |              | Schaden                  | Das bloße Auge              | Die Freilegung von Rissen im Inneren ist nicht zulässig             |
|                       | Linse        | Kratzen                  | Das bloße Auge              | Keine Auswirkung auf den Auflösungsstandard                         |
|                       |              | Kontamination            | Das bloße Auge              | Keine Auswirkung auf den Auflösungsstandard                         |
|                       |              | Ölfilm                   | Das bloße Auge              | Keine Auswirkung auf den Auflösungsstandard                         |
|                       |              | Abdeckband               | Das bloße Auge              | Kein Problem beim Aussehen.   |
|                       | Funktion     | Bild                     | Keine Kommunikation         | Testboard   |
| Helles Pixel          |              |                          | Tafel                       | Im Image Center nicht erlaubt                                       |
| Dunkles Pixel         |              |                          | Weißer Tafel                | Im Image Center nicht erlaubt                                       |
| Verschwommen          |              |                          | Das bloße Auge              | Nicht erlaubt   |
| Kein Bild             |              |                          | Das bloße Auge              | Nicht erlaubt   |
| Vertikale Linie       |              |                          | Das bloße Auge              | Nicht erlaubt   |
| Horizontale Linie     |              |                          | Das bloße Auge              | Nicht erlaubt   |
| Kleines Leck          |              |                          | Das bloße Auge              | Nicht erlaubt   |
| Blinkendes Bild       |              |                          | Das bloße Auge              | Nicht erlaubt   |
| Prellung              |              |                          | Inspektionslehre            | Nicht erlaubt   |
| Auflösung             |              |                          | Diagramm                    | Folgt dem Diagrammstandard für ausgehende Inspektionen              |
| Farbe                 |              |                          | Das bloße Auge              | Kein Problem  |
| Lärm                  |              |                          | Das bloße Auge              | Nicht erlaubt   |
| Ecke dunkel           |              |                          | Das bloße Auge              | Weniger als 100 x 100 Pixel   |
| Farbauflösung         |              |                          | Das bloße Auge              | Kein Problem  |
| Abmessungen           | Höhe         | Das bloße Auge           | Follows Approval Data Sheet |   |
|                       | Breite       | Das bloße Auge           | Follows Approval Data Sheet |   |
|                       | Länge        | Das bloße Auge           | Follows Approval Data Sheet |   |
|                       | Gesamt       | Das bloße Auge           | Follows Approval Data Sheet |   |



## KLT-Paketlösungen

KLT Kameramodul



Komplett mit Linsenschutzfolie



Tablett mit Gitter und Raum



Legen Sie die Kameras auf das Tablett



## Paketlösung für Kameramodule

Volles Tablett mit Kameras



Abdeckschale mit Deckel



In Antistatikbeutel stecken



Staubsaugen Sie den antistatischen Beutel





## Paketlösung für Kameramodule

Versiegelter Vakuumbbeutel mit Etiketten

1. Modell und Beschreibung 2. Menge 3. Versanddatum 4. Achtung





## Paketlösung für große Bestellungen

Schaumstoffplatten zwischen  
die Tablettis legen



Schaumstoffplatten sind etwas  
größer als Tablettis



Legen Sie Schaumstoffplatten und  
Tablettis in die Schachtel



Schaumstoffplatten sind eng anliegende Box





## Paketlösung für kleine Bestellungen

Legen Sie die Schaumstoffplatten und  
Tablets in die kleine Schachtel



Schaumstoffplatten passen gut in  
die kleine Box



Paket in kleiner Box für den Versand



Legen Sie kleine Kartons in größere Kartons





## Carbon Box Paketlösung

Verschließen Sie die Carbonbox

Beschriftete Schachtel mit Endverpackung



### Versandfertige Karbonbox

1. Lieferadresse und Telefonnummer
2. Box-Nr. und Versanddatum
3. Zerbrechliche Vorsicht



## Lösung für Musterbestellungspakete

Legen Sie die Probe in einen kleinen antistatischen Beutel



Stecken Sie die Anschlüsse in den kleinen antistatischen Beutel



### Musteretiketten auf dem kleinen Beutel

1. Kameramodul oder Anschlussmodell 2. Lieferdatum und Menge 3. Achtung





## Connectors Large Order Package Solution

Steckverbinder in einem Rad



Steckverbinder im Rad beschriftet



Das Rad passt perfekt in die Box



Steckerbox versandfertig



**Unternehmen Kai Lap Technologies (KLT)**

Kai Lap Technologies Group Limited. (KLT) wurde 2009 gegründet und ist ein technologiegetriebener Hersteller der nächsten Generation, der sich auf Forschung, Design und Produktion von Audio- und Videoprodukten spezialisiert hat. KLT verfügt über 20.000 Quadratfuß automatisierte Fabriken mit 100 Mitarbeitern und einem jährlichen Durchsatz von 30.000.000 Kameraeinheiten.

KLT bietet OEM-, ODM-Design, Auftragsfertigung und baut die Kameraprodukte. Sie können uns die Anforderungen auch mit einem Handentwurf übermitteln, unser Vertrieb und unsere Technik arbeiten zusammen, um Ihre Anforderungen zu erfüllen. Wir verstehen uns als Ihr langfristiger Partner bei der Entwicklung praktischer und innovativer Lösungen.

Unser Team deckt alles von der ersten Konzeptentwicklung bis zum Massenprodukt ab. KLT ist spezialisiert auf kundenspezifisches Kameradesign, Rohmaterial, Elektrotechnik, Firmware-/Softwareentwicklung, Produkttests und Verpackungsdesign. Unsere erfahrenen strategischen Versorgungssysteme bieten eine robuste und zuverlässige Fertigungskapazität für Aufträge unterschiedlicher Größe.

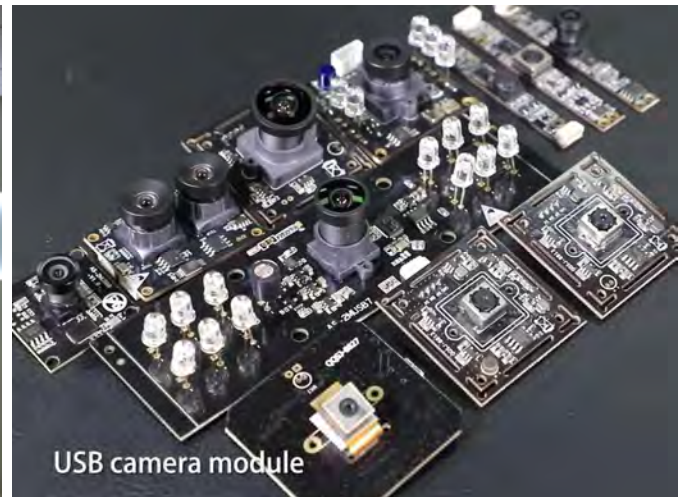
**Eingeschränkte Garantie**

KLT gewährt die folgende eingeschränkte Garantie, wenn Sie das/die Produkt(e) direkt von der Firma KLT oder von der Website von KLT, [www.KaiLapTech.com](http://www.KaiLapTech.com), gekauft haben. Produkte, die von anderen Verkäufern oder Quellen gekauft wurden, fallen nicht unter diese beschränkte Garantie. KLT garantiert, dass das/die Produkt(e) bei normalem Gebrauch für einen Zeitraum von einem (1) Jahr ab dem Datum, an dem Sie das Produkt erhalten („Garanzzeitraum“), frei von Material- und Verarbeitungsfehlern sind.

Für alle Produkte, die während des Garanzzeitraums Material- oder Verarbeitungsfehler enthalten oder entwickeln, wird KLT nach eigenem Ermessen entweder: (i) die Produkte reparieren; (ii) das/die Produkt(e) durch ein neues oder generalüberholtes Produkt(e) ersetzen (Ersatzprodukt(e) sind von identischem Modell oder funktionell gleichwertig); oder (iii) Ihnen den Preis erstatten, den Sie für das/die Produkt(e) gezahlt haben.

Diese eingeschränkte Garantie von KLT ist ausschließlich auf Reparatur und/oder Ersatz zu den oben genannten Bedingungen beschränkt. KLT ist nicht zuverlässig oder verantwortlich für nachfolgende Ereignisse.





# CMOS CAMERA MODULES



*your BEST camera module partner*

## KLT Stärke

Leistungsstarke Fabrik



## Professioneller Service



## Versprochene Lieferung



[www.KaiLapTech.com](http://www.KaiLapTech.com) [sales@KaiLapTech.com](mailto:sales@KaiLapTech.com) Tel: (852) 6908 1256 Fax: (852) 3017 6778

All rights reserved @ Kai Lap Technologies Group Ltd. Specifications subject to change without notice.